

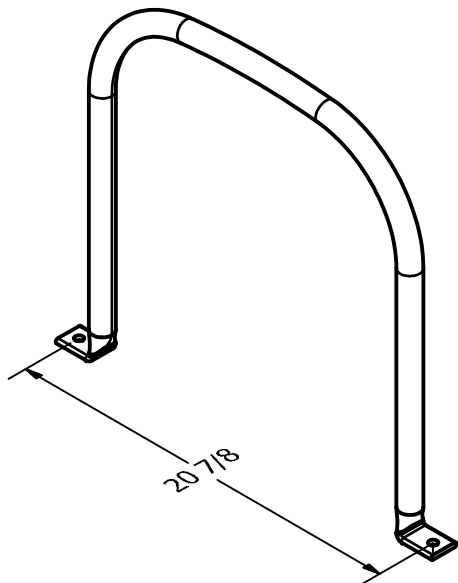

SECTION A-A  
SCALE 1/8

(2) HOLES, 7/16 DIA.

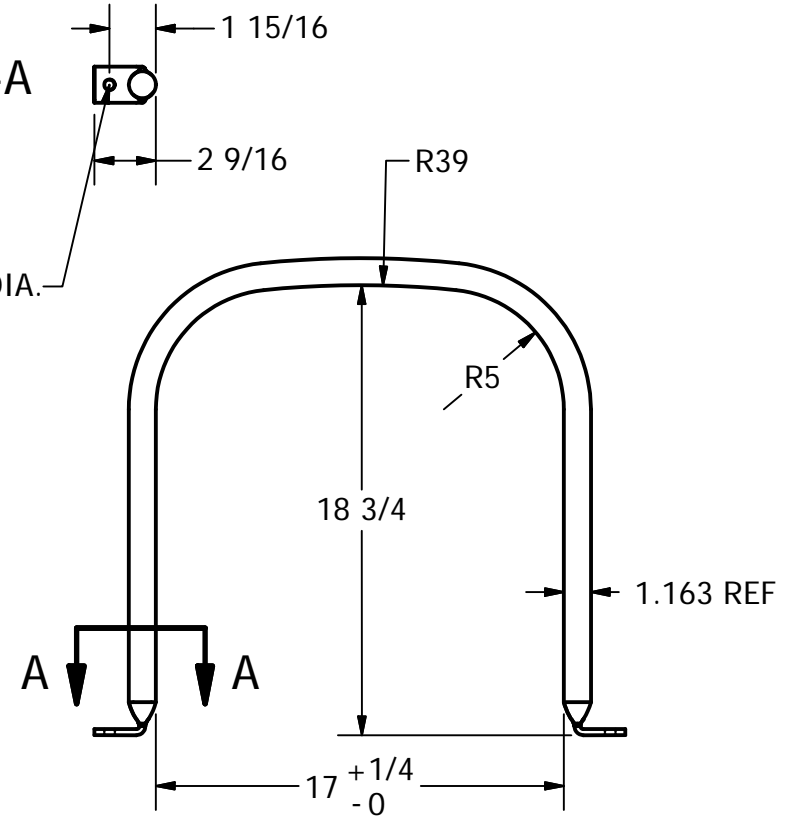

MAT'L: 1" ELECTRICAL METALLIC TUBING (EMT)

DRAWN Jerry Paulson	7/9/2010			
CHECKED		NORWESCO, INC., ST. BONIFACIUS, MN		
QA		TITLE		
MFG		HOOP, 50 GALLON FLAT BOTTOM UTILITY TANK		
APPROVED				
		SIZE A	DWG NO 63551	REV
		SCALE: 1/8	SHEET 1 OF 1	